

# Technical Information

## Useful Formulas

$$\frac{l/\text{min}}{\text{(Per Nozzle)}} = \frac{l/\text{ha} \times \text{km/h} \times W}{60,000}$$

$$l/\text{ha} = \frac{60,000 \times l/\text{min} \text{ (Per Nozzle)}}{\text{km/h} \times W}$$

l/min – Liters Per Minute

L/ha – Liters Per Hectare

km/h – Kilometers Per Hour

W – Nozzle spacing (in cm) for broadcast spraying

– Spray width (in cm) for single nozzle, band spraying or boomless spraying

– Row spacing (in cm) divided by the number of nozzles per row for directed spraying

## Nozzle Spacing

If the nozzle spacing on your boom is different than those tabulated, multiply the tabulated l/ha coverages by one of the following factors.

50 cm	
Other Spacing (cm)	Conversion Factor
20	2.5
25	2
30	1.67
35	1.43
40	1.25
45	1.11
60	.83
70	.71
75	.66

## Useful Formulas for Roadway Applications

$$l/\text{km} = \frac{60 \times l/\text{min}}{\text{km/hr}} \quad l/\text{min} = \frac{l/\text{km} \times \text{km/hr}}{60}$$

l/km = Liters Per Lane Kilometer

**Note:** l/km is not a normal volume per unit area measurement. It is a volume per distance measurement. Increases or decreases in lane width (swath width) are not accommodated by these formulas.

## Measuring Travel Speed

Measure a test course in the area to be sprayed or in an area with similar surface conditions. Minimum lengths of 30 and 60 meters are recommended for measuring speeds up to 8 and 14 km/h, respectively. Determine the time required to travel the test course. To help ensure accuracy, conduct the speed check with a partially loaded sprayer and select the engine throttle setting and gear that will be used when spraying. Repeat the above process and average the times that were measured. Use the following equation or the table at right to determine ground speed.

$$\text{Speed (km/h)} = \frac{\text{Distance (m)} \times 3.6}{\text{Time (seconds)}}$$

## Speeds

Speed in km/h	Time Required in SECONDS to Travel a Distance of:			
	30 m	60 m	90 m	120 m
5	22	43	65	86
6	18	36	54	72
7	15	31	46	62
8	14	27	41	54
9	—	24	36	48
10	—	22	32	43
11	—	20	29	39
12	—	18	27	36
13	—	17	25	33
14	—	15	23	31
16	—	14	20	27
18	—	—	18	24
20	—	—	16	22
25	—	—	13	17
30	—	—	—	14
35	—	—	—	12
40	—	—	—	11

75 cm	
Other Spacing (cm)	Conversion Factor
40	1.88
45	1.67
50	1.5
60	1.25
70	1.07
80	.94
90	.83
110	.68
120	.63

100 cm	
Other Spacing (cm)	Conversion Factor
70	1.43
75	1.33
80	1.25
85	1.18
90	1.11
95	1.05
105	.95
110	.91
120	.83

## Miscellaneous Conversion Factors

One Hectare = 10,000 Square Meters  
2.471 Acres

One Acre = 0.405 Hectare

One Liter Per Hectare = 0.1069 Gallon  
Per Acre

One Kilometer = 1,000 Meters  
= 3,300 Feet = 0.621 Mile





One Liter = 0.26 Gallon  
= 0.22 Imperial Gallon

One Bar = 100 Kilopascals  
= 14.5 Pounds Per Square Inch

One Kilometer Per Hour = 0.62 Mile  
Per Hour

## Suggested Minimum Spray Heights

The nozzle height suggestions in the table below are based on the minimum overlap required to obtain uniform distribution. However, in many cases, typical height adjustments are based on a 1 to 1 nozzle spacing to height ratio. For example, 110° flat spray tips spaced 50 cm apart are commonly set 50 cm above the target.

	(cm)			
				
 TeeJet® Standard, TJ	65°	75	100	NR*
TeeJet, XR, TX, DG, TJ	80°	60	80	NR*
TeeJet, XR, DG, TT, TTI, TJ, DGTJ, AI, AIXR	110°	40	60	NR*
FullJet®	120°	40**	60**	75**
FloodJet® TK, TF	120°	40***	60***	75***

\* Not recommended.

\*\* Nozzle height based on 30° to 45° angle of orientation (see page 30 of catalog).

\*\*\* Wide angle spray tip height is influenced by nozzle orientation. The critical factor is to achieve a double spray pattern overlap.

## Spraying Liquids with a Density Other Than Water

Since all the tabulations in this catalog are based on spraying water, which weighs 1 kilogram per liter, conversion factors must be used when spraying liquids that are heavier or lighter than water. To determine the proper size nozzle for the liquid to be sprayed, first multiply the desired l/min or l/ha of the spray liquid by the water rate conversion factor. Then use the new converted l/min or l/ha rate to select the proper size nozzle.

### Example:

Desired application rate is 100 l/ha of a liquid that has a density of 1.28 kg/L. Determine the correct nozzle size as follows:

$$\begin{aligned} & \text{l/ha (liquid other than water) x} \\ & \text{Conversion Factor} \\ & = \text{l/ha (from table in catalog)} \end{aligned}$$

$$\begin{aligned} & 100 \text{ l/ha (1.28 kg/L solution) x 1.13} \\ & = 113 \text{ l/ha (water)} \end{aligned}$$

The applicator should choose a nozzle size that will supply 113 l/ha of water at the desired pressure.

DENSITY - kg/L	CONVERSION FACTOR
0.84	0.92
0.96	0.98
1.00 - WATER	1.00
1.08	1.04
1.20	1.10
1.28 - 28% nitrogen	1.13
1.32	1.15
1.44	1.20
1.68	1.30

## Spray Coverage Information

This table lists the theoretical coverage of spray patterns as calculated from the included spray angle of the spray and the distance from the nozzle orifice. These values are based on the assumption that the spray angle remains the same throughout the entire spray distance. In actual practice, the tabulated spray angle does not hold for long spray distances.

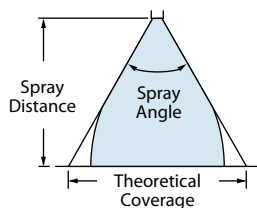

INCLUDED SPRAY ANGLE	THEORETICAL COVERAGE AT VARIOUS SPRAY HEIGHTS (IN cm)							
	20 cm	30 cm	40 cm	50 cm	60 cm	70 cm	80 cm	90 cm
15°	5.3	7.9	10.5	13.2	15.8	18.4	21.1	23.7
20°	7.1	10.6	14.1	17.6	21.2	24.7	28.2	31.7
25°	8.9	13.3	17.7	22.2	26.6	31.0	35.5	39.9
30°	10.7	16.1	21.4	26.8	32.2	37.5	42.9	48.2
35°	12.6	18.9	25.2	31.5	37.8	44.1	50.5	56.8
40°	14.6	21.8	29.1	36.4	43.7	51.0	58.2	65.5
45°	16.6	24.9	33.1	41.4	49.7	58.0	66.3	74.6
50°	18.7	28.0	37.3	46.6	56.0	65.3	74.6	83.9
55°	20.8	31.2	41.7	52.1	62.5	72.9	83.3	93.7
60°	23.1	34.6	46.2	57.7	69.3	80.8	92.4	104
65°	25.5	38.2	51.0	63.7	76.5	89.2	102	115
73°	29.6	44.4	59.2	74.0	88.8	104	118	133
80°	33.6	50.4	67.1	83.9	101	118	134	151
85°	36.7	55.0	73.3	91.6	110	128	147	165
90°	40.0	60.0	80.0	100	120	140	160	180
95°	43.7	65.5	87.3	109	131	153	175	196
100°	47.7	71.5	95.3	119	143	167	191	215
110°	57.1	85.7	114	143	171	200	229	257
120°	69.3	104	139	173	208	243		
130°	85.8	129	172	215	257			
140°	110	165	220	275				
150°	149	224	299					

## Nozzle Nomenclature

There are many types of nozzles available, with each providing different flow rates, spray angles, droplet sizes and patterns. Some of these spray tip characteristics are indicated by the tip number.

**Remember, when replacing tips, be sure to purchase the same tip number, thereby ensuring your sprayer remains properly calibrated.**

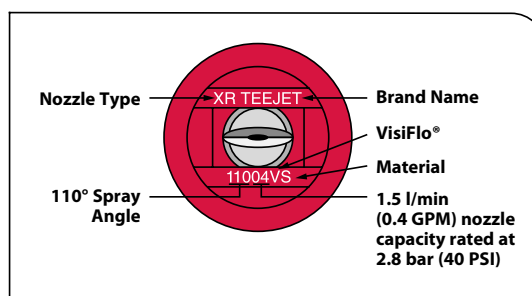

# Information About Spray Pressure

## Flow Rate

Nozzle flow rate varies with spraying pressure. In general, the relationship between l/min and pressure is as follows:

$$\frac{l/min_1}{l/min_2} = \frac{\sqrt{\text{bar}_1}}{\sqrt{\text{bar}_2}}$$

This equation is explained by the illustration to the right. Simply stated, in order to double the flow through a nozzle, the pressure must be increased four times.

Higher pressure not only increases the flow rate through a nozzle, but it also influences the droplet size and the rate of orifice wear. As pressure is increased, the droplet size decreases and the rate of orifice wear increases.

The values given in the tabulation sections of this catalog indicate the most commonly used pressure ranges for the associated spray tips. When information on the performance of spray tips outside of the pressure range given in this catalog is required, contact the Agricultural Division at Spraying Systems Co.®

## Spray Angle and Coverage

Depending on the nozzle type and size, the operating pressure can have a significant effect on spray angle and quality of spray distribution. As shown here for an 11002 flat spray tip, lowering the pressure results in a smaller spray angle and a significant reduction in spray coverage.

Tabulations for spray tips in this catalog are based on spraying water. Generally, liquids more viscous than water produce relatively smaller spray angles, while liquids with surface tensions lower than water will produce wider spray angles. In situations where the uniformity of spray distribution is important, be careful to operate your spray tips within the proper pressure range.

**Note:** Suggested minimum spray heights for broadcast spraying are based upon nozzles spraying water at the rated spray angle.

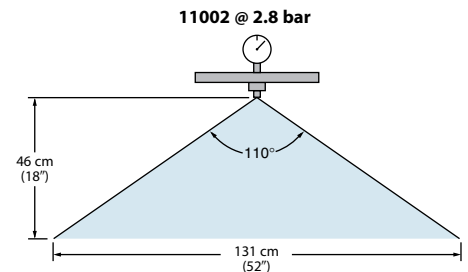
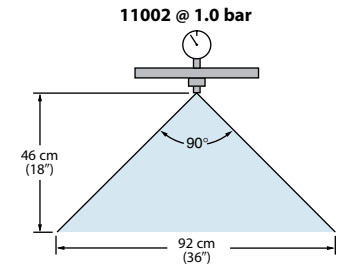
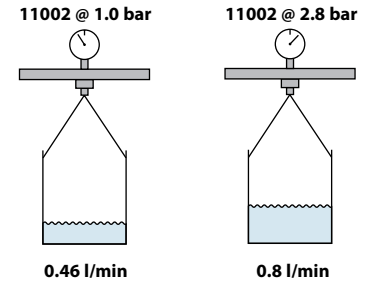

## Pressure Drop Through Sprayer Components

COMPONENT NUMBER	TYPICAL PRESSURE DROP (bar) AT VARIOUS FLOW RATES (l/min)									
	10 l/min	18 l/min	26 l/min	30 l/min	34 l/min	38 l/min	56 l/min	68 l/min	120 l/min	
AA2 GunJet®	0.14	0.37	0.69		1.1					
AA18 GunJet	0.34	0.90	1.7		2.8					
AA30L GunJet		0.97								
AA43 GunJet		0.69	0.14							
AA143 GunJet		0.06	0.12			0.24	0.54			
AA6B Valve		0.10	0.17	0.24	0.28	0.34	0.79	1.1		
AA17 Valve		0.10	0.17	0.24	0.28	0.34	0.79	1.1		
AA144A Valve		0.10	0.17	0.24	0.28	0.34	0.79	1.1		
AA144A-1-3 Valve				0.34						
AA145 Valve								0.34		
344BEC-24-C Valve									0.34	

## Pressure Drop Through Various Hose Sizes

FLOW IN l/min	PRESSURE DROP IN 3 m (10') LENGTH WITHOUT COUPLINGS									
	6.4 mm		9.5 mm		12.7 mm		19.0 mm		25.4 mm	
	bar	Kpa	bar	Kpa	bar	Kpa	bar	Kpa	bar	Kpa
1.9	0.1	9.6		1.4						
3.8				4.8						
5.8			0.1	9.6		2.8				
7.7			0.2	16.5		4.1				
9.6			0.2	23.4	0.1	6.2				
11.5					0.1	8.3				
15.4					0.1	13.8				
19.2					0.2	20.0		2.8		
23.1					0.3	27.6		4.1		
30.8							0.1	6.2		2.1
38.5							0.1	9.6		2.8

# Area Measurement

It is essential to know the amount of area that you intend to cover when applying a pesticide or fertilizer. Turf areas such as home lawns and golf course greens, tees and fairways should be measured in square feet or acres, depending upon the units needed.

## Rectangular Areas

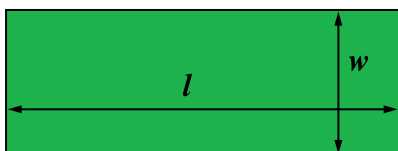

$$\text{Area} = \text{Length } (l) \times \text{Width } (w)$$

### Example:

What is the area of a lawn that is 150 meters long by 75 meters wide?

$$\begin{aligned} \text{Area} &= 150 \text{ meters} \times 75 \text{ meters} \\ &= 11,250 \text{ square meters} \end{aligned}$$

By using the following equation, it is possible to determine the area in hectares.

$$\text{Area in hectares} = \frac{\text{Area in square meters}}{10,000 \text{ square meters per hectare}}$$

(There are 10,000 square meters in a hectare.)

### Example:

$$\begin{aligned} \text{Area in hectares} &= \frac{11,250 \text{ square meters}}{10,000 \text{ square meters per hectare}} \\ &= 1.125 \text{ hectares} \end{aligned}$$

## Triangular Areas

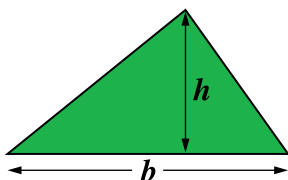

$$\text{Area} = \frac{\text{Base } (b) \times \text{Height } (h)}{2}$$

### Example:

The base of a corner lot is 120 meters while the height is 50 meters. What is the area of the lot?

$$\begin{aligned} \text{Area} &= \frac{120 \text{ meters} \times 50 \text{ meters}}{2} \\ &= 3,000 \text{ square meters} \\ \text{Area in hectares} &= \frac{3,000 \text{ square meters}}{10,000 \text{ square meters per hectare}} \\ &= 0.30 \text{ hectare} \end{aligned}$$

## Circular Areas

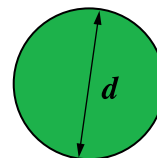

$$\text{Area} = \frac{\pi \times \text{Diameter}^2 (d)}{4}$$

$$\pi = 3.14159$$

### Example:

What is the area of a green that has a diameter of 15 meters?

$$\begin{aligned} \text{Area} &= \frac{\pi \times (15 \text{ meters})^2}{4} = \frac{3.14 \times 225}{4} \\ &= 177 \text{ square meters} \end{aligned}$$

$$\begin{aligned} \text{Area in hectares} &= \frac{177 \text{ square meters}}{10,000 \text{ square meters per hectare}} \\ &= 0.018 \text{ hectare} \end{aligned}$$

## Irregular Areas

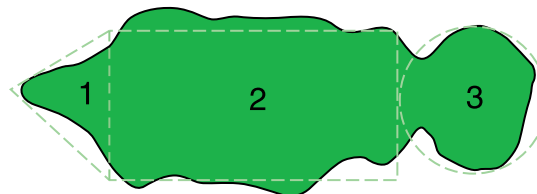

Any irregularly shaped turf area can usually be reduced to one or more geometric figures. The area of each figure is calculated and the areas are then added together to obtain the total area.

### Example:

What is the total area of the Par-3 hole illustrated above?

The area can be broken into a triangle (area 1), a rectangle (area 2) and a circle (area 3). Then use the previously mentioned equations for determining areas to find the total area.

$$\begin{aligned} \text{Area 1} &= \frac{15 \text{ meters} \times 20 \text{ meters}}{2} = 150 \text{ square meters} \\ \text{Area 2} &= 15 \text{ meters} \times 150 \text{ meters} = 2,250 \text{ square meters} \\ \text{Area 3} &= \frac{3.14 \times (20)^2}{4} = 314 \text{ square meters} \\ \text{Total Area} &= 150 + 2,250 + 314 = 2,714 \text{ square meters} \\ &= \frac{2,714 \text{ square meters}}{10,000 \text{ square meters per hectare}} = 0.27 \text{ hectare} \end{aligned}$$

# Sprayer Calibration

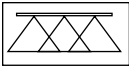

## Broadcast Application

Sprayer calibration (1) **readies your sprayer for operation** and (2) **diagnoses tip wear**. This will give you optimum performance of your TeeJet® tips.

### Equipment Needed:

- TeeJet Calibration Container
- Calculator
- TeeJet Cleaning Brush
- One new TeeJet Spray Tip matched to the nozzles on your sprayer
- Stopwatch or wristwatch with second hand

## STEP NUMBER 1

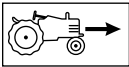

## Check Your Tractor/Sprayer Speed!

Knowing your real sprayer speed is an essential part of accurate spraying. Speedometer readings and some electronic measurement devices can be inaccurate because of wheel slippage. Check the time required to move over a 30- or 60-meter strip on your field. Fence posts can serve as permanent markers. The starting post should be far enough away to permit your tractor/sprayer to reach desired spraying speed. Hold that speed as you travel between the “start” and “end” markers. Most accurate measurement will be obtained with the spray tank half full. Refer to the table on page 173 to calculate your real speed. When the correct throttle and gear settings are identified, mark your tachometer or speedometer to help you control this vital part of accurate chemical application.

## STEP NUMBER 2

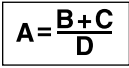

## The Inputs

Before spraying, record the following:

	EXAMPLE
Nozzle type on your sprayer. . . . .	TT11004 Flat Spray Tip
(All nozzles must be identical)	
Recommended application volume . . . . .	190 l/ha
(From manufacturer's label)	
Measured sprayer speed . . . . .	10 km/h
Nozzle spacing. . . . .	50 cm



## STEP NUMBER 3

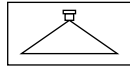

## Calculating Required Nozzle Output

Determine l/min nozzle output from formula.

$$\text{FORMULA: } \text{l/min} = \frac{\text{l/ha} \times \text{km/h} \times \text{W}}{60,000}$$

$$\text{EXAMPLE: } \text{l/min} = \frac{190 \times 10 \times 50}{60,000}$$

**ANSWER:** 1.58 l/min

## STEP NUMBER 4



## Setting the Correct Pressure

Turn on your sprayer and check for leaks or blockage. Inspect and clean, if necessary, all tips and strainers with TeeJet brush. Replace one tip and strainer **with an identical new tip and strainer** on sprayer boom.

Check appropriate tip selection table and determine the pressure required to deliver the nozzle output calculated from the formula in Step 3 for your new tip. Since all of the tabulations are based on spraying water, conversion factors must be used when spraying solutions that are heavier or lighter than water (see page 174).

**Example:** (Using above inputs) refer to TeeJet table on page 9 for TT11004 flat spray tip. The table shows that this nozzle delivers 1.58 l/min at 3 bar.

Turn on your sprayer and adjust pressure. **Collect and measure the volume of the spray from the new tip for one minute in the collection jar.** Fine tune the pressure until you collect 1.58 l/min.

You have now adjusted your sprayer to the proper pressure. It will properly deliver the application rate specified by the chemical manufacturer at your measured sprayer speed.

## STEP NUMBER 5



## Checking Your System

**Problem Diagnosis:** Now, check the flow rate of a few tips on each boom section. If the flow rate of any tip is 10 percent greater or less than that of the newly installed spray tip, recheck the output of that tip. If only one tip is faulty, replace with new tip and strainer and your system is ready for spraying. However, if a second tip is defective, **replace all tips on the entire boom**. This may sound unrealistic, but two worn tips on a boom are ample indication of tip wear problems. Replacing only a couple of worn tips invites potentially serious application problems.

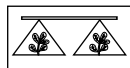

## Banding and Directed Applications

The only difference between the above procedure and calibrating for banding or directed applications is the input value used for “W” in the formula in Step 3.

For single nozzle banding or boomless applications:

$$W = \text{Sprayed band width or swath width (in cm).}$$

For multiple nozzle directed applications:

$$W = \text{Row spacing (in cm) divided by the number of nozzles per row.}$$

$$A = \frac{B+C}{D}$$

# Calibration/Adjustment Accessories

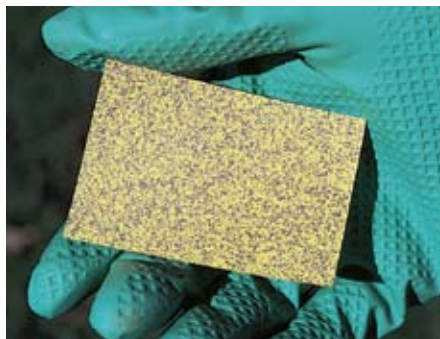

## Water and Oil Sensitive Paper

These specially coated papers are used for evaluating spray distributions, swath widths, droplet densities and penetration of spray. Water sensitive paper is yellow and is stained blue by exposure to aqueous spray droplets. White oil sensitive paper turns black in areas exposed to oil droplets. For more information on water sensitive paper write for data sheet 20301; for information on oil sensitive paper write for data sheet 20302.

Water and oil sensitive paper sold by Spraying Systems Co. is manufactured by Syngenta Crop Protection AG.



## TeeJet® Tip Tester

The TeeJet Tip Tester helps identify worn spray tips quickly and easily. This handheld flowmeter allows you to check all spray tips for uniform flow rates in minutes. Just attach the adapter over a spray tip and read the approximate flow rate directly from the dual measurement scale. An adapter is provided to fit all types of conventional and quick-attach nozzle caps. Each tip tester is supplied with a TeeJet nozzle cleaning brush in the built-in storage compartment.

**How to order:**  
Specify part number.  
Example: 37670



## TeeJet Pattern Check

Successful applications depend on a quality pattern from your spray tips and proper operation of your spraying equipment. The TeeJet Pattern Check makes it easy to see if your sprayer is properly set up to provide the even distribution needed for safe and effective pest control. By sliding the pattern check under the sprayer boom while spraying clean water, you get an immediate indication of the spray distribution along the boom.

**How to order:**  
Specify part number.  
Example: 37685

WATER SENSITIVE PAPER		
PART NUMBER	PAPER SIZE	QUANTITY/PACKAGE
20301-1N	76 mm x 26 mm	50 cards
20301-2N	76 mm x 52 mm	50 cards
20301-3N	500 mm x 26 mm	25 strips

OIL SENSITIVE PAPER		
PART NUMBER	PAPER SIZE	QUANTITY/PACKAGE
20302-1	76 mm x 52 mm	50 cards

### How to order:

Specify part number.  
Example: 20301-1N  
Water Sensitive Paper

## TeeJet Tip Cleaning Brush



### How to order:

Specify part number.  
Example: CP20016-NY



## TeeJet Calibration Container

The TeeJet Calibration Container features a 68 oz. (2.0 L) capacity and a raised dual scale in both U.S. and metric graduations. The container is molded of polypropylene for excellent chemical resistance and durability.

**How to order:**  
Example: CP24034A-PP  
(Calibration Container only)

## TeeJet 38560 Wind Meter

- Measures wind velocity on three scales: Beaufort, MPH (miles per hour) and m/sec (meters per second).
- Wide wind velocity range.
- Compact and lightweight for convenient transport and storage.
- Easy to operate and maintain.



### How to order:

Specify part number.  
Example: 38560

# Spray Tip Wear

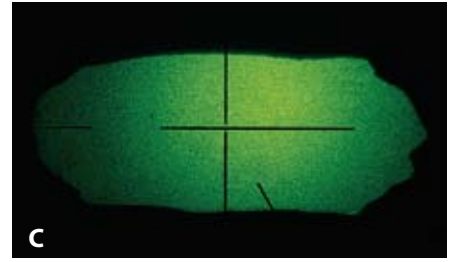
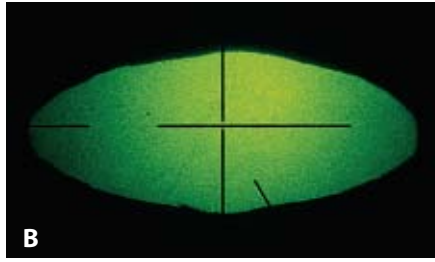
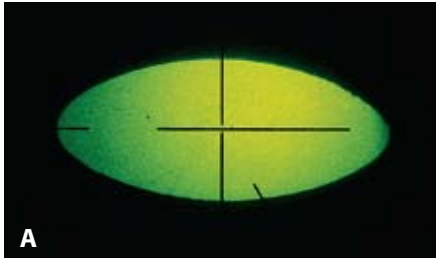

## Tips Don't Last Forever!

There is sufficient evidence that spray tips may be the most neglected component in today's farming. Even in countries with obligatory sprayer testing, spray tips are the most significant failure. On the other hand, they are among the most critical of items in proper application of valuable agricultural chemicals.

For example, a 10 percent over-application of chemical on a twice-sprayed 200-hectare farm could represent a loss of U.S. \$1,000–\$5,000 based on today's chemical investments of \$25.00–\$125.00 per hectare. This does not take into account potential crop damage.

## Spray Tip Care is the First Step to Successful Application

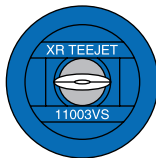

The successful performance of a crop chemical is highly dependent on its proper application as recommended by the chemical manufacturer. Proper selection and operation of spray nozzles are very important steps in accurate chemical application. The volume of spray passing through each nozzle plus the droplet size and spray distribution on the target can influence pest control.

Critical in controlling these three factors is the spray nozzle orifice. Careful craftsmanship

## An Inside Look at Nozzle Orifice Wear and Damage

While wear may not be detected when visually inspecting a nozzle, it can be seen when viewed through an optical comparator. The edges of the worn nozzle (B) appear more rounded than the edges of the new nozzle (A). Damage to nozzle (C) was caused by improper cleaning. The spraying results from these tips can be seen in the illustrations below.

goes into the precision manufacturing of each nozzle orifice. European standards, for example the BBA, require very small flow tolerances of new nozzles (+/-5%) of nominal flow. Many TeeJet nozzle types and sizes are already BBA-approved, which confirms the high quality standard designed into TeeJet nozzles. To maintain the quality in practical spraying as long as possible, the operator's job is the proper maintenance of those spray tips.

The illustration below compares the spraying results obtained from well-maintained vs. poorly-maintained spray tips. Poor spray distribution can be prevented. Selection of longer wearing tip materials or frequent replacement of tips from softer materials can eliminate misapplication due to worn spray tips.

## Determining Tip Wear

The best way to determine if a spray tip is excessively worn is to compare the flow rate from the used tip to the flow rate of a new tip of the same size and type. Charts in this catalog indicate the flow rates for new nozzles. Check the flow of each tip by using an accurate graduated collection container, a timing device and an accurate pressure gauge mounted at the nozzle tip. Compare the flow rate of the old tip to that of the new one. Spray tips are considered excessively worn and should be replaced when their flow exceeds the flow of a new tip by 10%. Reference page 177 for more information.

Careful cleaning of a clogged spray tip can mean the difference between a clean field and one with weed streaks. Flat spray tips have finely crafted thin edges around the orifice to control the spray. Even the slightest damage from improper cleaning can cause both an increased flow rate and poor spray distribution. Be sure to use adequate strainers in your spray system to minimize clogging. If a tip does clog, only use a soft bristled brush or toothpick to clean it – never use a metal object. Use extreme care with soft tip materials such as plastic. Experience has shown that even a wooden toothpick can distort the orifice.

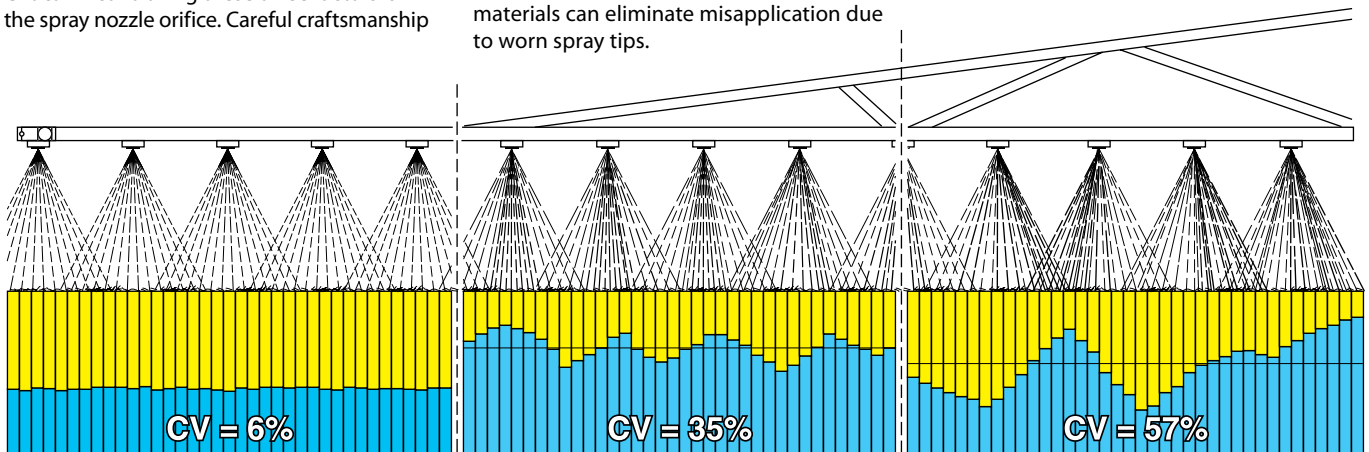

**NEW SPRAY TIPS**  
Produce a uniform distribution when properly overlapped.

**WORN SPRAY TIPS**  
Have a higher output with more spray concentrated under each tip.

**DAMAGED SPRAY TIPS**  
Have a very erratic output – overapplying and underapplying.

One of the most overlooked factors that can dramatically influence the effectiveness of a given crop production chemical is spray distribution. The uniformity of the spray distribution across the boom or within the spray swath is an essential component to achieving maximum chemical effectiveness with minimal cost and minimal non-target contamination. This is more than critical if carrier and chemical rates are applied at the recommended minimum rate. There are many other factors influencing a crop production chemical's effectiveness, such as weather, application timing, active ingredient rates, pest infestation, etc. However, an operator must become aware of spray distribution quality if maximum efficiency is expected.

## Measurement Techniques

Spray distribution can be measured in different ways. Spraying Systems Co.<sup>®</sup>, and some sprayer manufacturers, as well as other research and testing stations, have patternators (spray tables) that collect the spray from nozzles on a standardized or real boom. These patternators have a number of channels aligned perpendicular to the nozzle spray. The channels carry the spray liquid into vessels for measuring and analysis (see photo with TeeJet patternator). Under controlled conditions, very accurate distribution measurements can be made for nozzle evaluation and development. Distribution measurements can also take place on an actual farm sprayer. For static measurements along the sprayer boom, a patternator equal or very similar to the one described earlier is placed under

the boom in a stationary position or as a small patternator unit scanning the whole boom up to a width of 50 m. Any system of patternator measures electronically the quantity of water in each channel and calculates the values. A distribution quality test gives the applicator important information about the state of the nozzles on the boom. When much more detailed information about spray quality and coverage is required, a dynamic system—spraying a tracer (dye)—can be used. The same is true if the distribution within the swath on a boom has to be measured. Currently, only a few test units worldwide have the ability to perform a stationary test. These tests usually involve shaking or moving the spray boom to simulate actual field and application conditions.

Most of the distribution measuring devices result in data points representing the sprayer's boom swath uniformity. These data points can be very revealing just through visual observation. However, for comparison reasons, a statistical method is widely accepted. This method is Coefficient of Variation (Cv). The Cv compiles all the patternator data points and summarizes them into a simple percentage, indicating the amount of variation within a given distribution. For extremely uniform distributions under accurate conditions, the Cv can be  $\leq 7\%$ . In some European countries, nozzles must conform to very strict Cv specifications, while other countries may require the sprayer's distribution to be tested for uniformity every one or two years. These types of stipulations emphasize the great importance of distribution quality and its effect on crop production effectiveness.

## Factors Affecting Distribution

There are a number of factors contributing to the distribution quality of a spray boom or resulting Cv percentage. During a static measurement, the following factors can significantly affect the distribution.

- Nozzles
    - type
    - pressure
    - spacing
    - spray angle
    - offset angle
    - spray pattern quality
    - flow rate
    - overlap
  - Boom Height
  - Worn Nozzles
  - Pressure Losses
  - Plugged Filters
  - Plugged Nozzles
  - Plumbing Factors Influencing Liquid Turbulence at Nozzle
- Additionally, in the field during the spraying application or during a dynamic distribution test, the following can influence the distribution quality:
- Boom Stability
    - vertical movement (pitch)
    - horizontal movement (yaw)
  - Environmental Conditions
    - wind velocity
    - wind direction
  - Pressure Losses (sprayer plumbing)
  - Sprayer Speed and Resulting Turbulence

The effect of distribution uniformity on the efficiency of a crop production chemical can vary under different circumstances. The crop production chemical itself can have dramatic influence over its efficiency. Always consult the manufacturer's chemical label or recommendation before spraying.



# Droplet Size and Drift Information

A nozzle's spray pattern is made up of numerous spray droplets of varying sizes. Droplet size refers to the diameter of an individual spray droplet.

Since most nozzles have a wide distribution of droplet sizes (otherwise known as droplet spectrum), it is useful to summarize this with statistical analysis. Most advanced drop size measuring devices are automated, using computers and high-speed illumination sources such as lasers to analyze thousands of droplets in a few seconds. Through statistics, this large volume of data can be reduced to a single number that is representative of the drop sizes contained in the spray pattern and can then be classified into droplet size classes. These classes (very fine, fine, medium, coarse, very coarse,

and extremely coarse) can then be used to compare one nozzle to another. Care must be taken when comparing one nozzle's drop size to another, as the specific testing procedure and instrument can bias the comparison.

Droplet sizes are usually measured in microns (micrometers). One micron equals 0.001 mm. The micron is a useful unit of measurement because it is small enough that whole numbers can be used in drop size measurement.

The majority of agricultural nozzles can be classified as producing either fine, medium, coarse or very coarse droplets. A nozzle with a coarse or very coarse droplet is usually selected to minimize off-target spray drift, while a nozzle with a fine droplet

is required to obtain maximum surface coverage of the target plant.

To show comparisons between nozzle types, spray angle, pressure and flow rate, refer to the droplet size classes shown in the tables on pages 182–183.

Another droplet size measurement that is useful for determining a nozzle's drift potential is the percentage of driftable fines. Since the smaller droplets have a greater tendency to move off-target, it makes sense to determine what the percentage of small droplets is for a particular nozzle in order to minimize it when drift is a concern. Droplets below 200 microns are considered potential drift contributors. The table below shows several nozzles and their percentage of driftable fines.

Spraying Systems Co.<sup>®</sup> uses the most advanced measuring instrumentation (PDPA and Oxford lasers) to characterize sprays, obtaining droplet size and other important information. For the latest accurate information about nozzles and their droplet size, please contact your nearest TeeJet representative.



## Driftable Droplets\*

NOZZLE TYPE (1.16 l/min FLOW)	APPROXIMATE PERCENT OF SPRAY VOLUME LESS THAN 200 MICRONS	
	1.5 bar	3 bar
XR TeeJet <sup>®</sup> 110°	14%	34%
XR TeeJet <sup>®</sup> 80°	2%	23%
DG TeeJet <sup>®</sup> 110°	<1%	20%
DG TeeJet <sup>®</sup> 80°	<1%	16%
TT – Turbo TeeJet <sup>®</sup>	<1%	12%
TF – Turbo FloodJet <sup>®</sup>	<1%	<1%
AI TeeJet <sup>®</sup> 110°	N/A	<1%

\*Data obtained by spraying water at room temperature under laboratory conditions.

$$A = \frac{B+C}{D}$$

# Drop Size Classification

Nozzle selection is often based upon droplet size. The droplet size from a nozzle becomes very important when the efficacy of a particular plant protection chemical is dependent on coverage, or the prevention of spray leaving the target area is a priority.

The majority of the nozzles used in agriculture can be classified as producing either fine, medium, coarse, or very coarse droplets. Nozzles that produce fine droplets are usually recommended for post-emergence applications, which require excellent coverage on the intended target area. The most common nozzles used in agriculture are those that produce medium-sized droplets. Nozzles producing medium- and

coarse-sized droplets can be used for contact and systemic herbicides, pre-emergence surface-applied herbicides, insecticides and fungicides.

An important point to remember when choosing a spray nozzle that produces a droplet size in one of the six categories is that one nozzle can produce different droplet size classifications at different pressures. A nozzle might produce medium droplets at low pressures, while producing fine droplets as pressure is increased.

Droplet size classes are shown in the following tables to assist in choosing an appropriate spray tip.

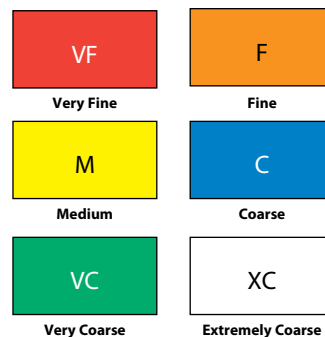

Droplet size classifications are based on BCPC specifications and in accordance with ASAE Standard S-572 at the date of printing. Classifications are subject to change.

## AIXR TeeJet® (AIXR)

	bar										
	1	1.5	2	2.5	3	3.5	4	4.5	5	5.5	6
AIXR110015	XC	VC	VC	C	C	C	C	M	M	M	M
AIXR11002	XC	XC	VC	VC	C	C	C	C	C	M	M
AIXR110025	XC	XC	XC	VC	VC	C	C	C	C	C	C
AIXR11003	XC	XC	XC	VC	VC	C	C	C	C	C	C
AIXR11004	XC	XC	XC	XC	VC	VC	VC	C	C	C	C
AIXR11005	XC	XC	XC	XC	XC	VC	VC	VC	C	C	C
AIXR11006	XC	XC	XC	XC	XC	VC	VC	VC	C	C	C

## Turbo TeeJet® (TT) and Turbo TeeJet® Duo (QJ90-2XTT)

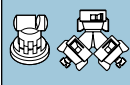
	bar										
	1	1.5	2	2.5	3	3.5	4	4.5	5	5.5	6
TT11001 QJ90-2XTT11001	C	M	M	M	F	F	F	F	F	F	F
TT110015 QJ90-2XTT110015	C	C	M	M	M	M	M	F	F	F	F
TT11002 QJ90-2XTT11002	C	C	C	M	M	M	M	M	M	M	F
TT110025 QJ90-2XTT110025	VC	C	C	M	M	M	M	M	M	M	M
TT11003 QJ90-2XTT11003	VC	C	C	C	C	M	M	M	M	M	M
TT11004 QJ90-2XTT11004	XC	VC	C	C	C	C	C	C	M	M	M
TT11005 QJ90-2XTT11005	XC	VC	VC	VC	C	C	C	C	C	M	M
TT11006 QJ90-2XTT11006	XC	VC	VC	VC	C	C	C	C	C	C	M
TT11008 QJ90-2XTT11008	XC	XC	VC	VC	C	C	C	C	C	C	M

## Turbo TwinJet® (TTJ60)

	bar										
	1	1.5	2	2.5	3	3.5	4	4.5	5	5.5	6
TTJ60-11002	VC	C	C	C	C	M	M	M	M	M	M
TTJ60-110025	XC	VC	C	C	C	C	C	C	M	M	M
TTJ60-11003	XC	VC	C	C	C	C	C	C	C	M	M
TTJ60-11004	XC	VC	C	C	C	C	C	C	C	C	M
TTJ60-11005	XC	VC	C	C	C	C	C	C	C	C	C
TTJ60-11006	XC	XC	VC	C	C	C	C	C	C	C	C

## AI TeeJet® (AI) and AIC TeeJet® (AIC)

	bar											
	2	2.5	3	3.5	4	4.5	5	5.5	6	6.5	7	8
AI110015	VC	VC	VC	VC	C	C	C	C	C	C	C	C
AI11002	VC	VC	VC	VC	VC	C	C	C	C	C	C	C
AI110025	XC	VC	VC	VC	VC	VC	VC	C	C	C	C	C
AI11003	XC	XC	VC	VC	VC	VC	VC	VC	C	C	C	C
AI11004	XC	XC	VC	VC	VC	VC	VC	VC	VC	C	C	C
AI11005	XC	XC	XC	VC	VC	VC	VC	VC	VC	C	C	C
AI11006	XC	XC	XC	VC	VC	VC	VC	VC	VC	VC	C	C
AI11008	XC	XC	XC	XC	VC	VC	VC	VC	VC	VC	C	C
AI11010	XC	XC	XC	XC	VC	VC	VC	VC	VC	VC	VC	C

## Turbo TeeJet® Induction (TTI)

	bar											
	1	1.5	2	2.5	3	3.5	4	4.5	5	5.5	6	7
TTI110015	XC	XC	XC	XC	XC	XC	XC	XC	XC	XC	XC	XC
TTI11002	XC	XC	XC	XC	XC	XC	XC	XC	XC	XC	XC	XC
TTI110025	XC	XC	XC	XC	XC	XC	XC	XC	XC	XC	XC	XC
TTI11003	XC	XC	XC	XC	XC	XC	XC	XC	XC	XC	XC	XC
TTI11004	XC	XC	XC	XC	XC	XC	XC	XC	XC	XC	XC	XC
TTI11005	XC	XC	XC	XC	XC	XC	XC	XC	XC	XC	XC	XC
TTI11006	XC	XC	XC	XC	XC	XC	XC	XC	XC	XC	XC	XC

**XR TeeJet® (XR) and XRC TeeJet® (XRC)**

	bar						
	1	1.5	2	2.5	3	3.5	4
XR8001	M	F	F	F	F	F	F
XR80015	M	M	F	F	F	F	F
XR8002	M	M	M	M	F	F	F
XR8003	M	M	M	M	M	M	M
XR8004	C	M	M	M	M	M	M
XR8005	C	C	C	M	M	M	M
XR8006	C	C	C	C	C	C	C
XR8008	VC	VC	C	C	C	C	C
XR11001	F	F	F	F	F	VF	VF
XR110015	F	F	F	F	F	F	F
XR11002	M	F	F	F	F	F	F
XR110025	M	M	F	F	F	F	F
XR11003	M	M	F	F	F	F	F
XR11004	M	M	M	M	M	F	F
XR11005	C	M	M	M	M	M	M
XR11006	C	C	M	M	M	M	M
XR11008	C	C	C	C	M	M	M

**TeeJet® (TP)**

	bar				
	2	2.5	3	3.5	4
TP8001	F	F	F	F	F
TP80015	F	F	F	F	F
TP8002	M	M	F	F	F
TP8003	M	M	M	M	M
TP8004	M	M	M	M	M
TP8005	C	M	M	M	M
TP8006	C	C	C	C	C
TP8008	C	C	C	C	C
TP11001	F	F	F	VF	VF
TP110015	F	F	F	F	F
TP11002	F	F	F	F	F
TP11003	F	F	F	F	F
TP11004	M	M	M	F	F
TP11005	M	M	M	M	M
TP11006	M	M	M	M	M
TP11008	C	C	M	M	M

**TurfJet® (TTJ)**

	bar				
	2	3	3.5	4	4.5
1/4TTJ02-VS	XC	XC	XC	XC	XC
1/4TTJ04-VS	XC	XC	XC	XC	XC
1/4TTJ05-VS	XC	XC	XC	XC	XC
1/4TTJ06-VS	XC	XC	XC	XC	XC
1/4TTJ08-VS	XC	XC	XC	XC	XC
1/4TTJ10-VS	XC	XC	XC	XC	XC
1/4TTJ15-VS	XC	XC	XC	XC	XC

**Turbo FloodJet® (TF)**

	bar				
	1	1.5	2	2.5	3
TF-2	XC	XC	XC	XC	XC
TF-2.5	XC	XC	XC	XC	XC
TF-3	XC	XC	XC	XC	XC
TF-4	XC	XC	XC	XC	XC
TF-5	XC	XC	XC	XC	XC
TF-7.5	XC	XC	XC	XC	XC
TF-10	XC	XC	XC	XC	XC

**DG TwinJet® (DG-TJ60)**

	bar				
	2	2.5	3	3.5	4
DGTJ60-110015	F	F	F	F	F
DGTJ60-11002	M	M	F	F	F
DGTJ60-11003	C	M	M	M	M
DGTJ60-11004	C	C	C	C	C
DGTJ60-11006	C	C	C	C	C
DGTJ60-11008	C	C	C	C	C

**TwinJet® (TJ)**

	bar				
	2	2.5	3	3.5	4
TJ60-6501	F	VF	VF	VF	VF
TJ60-650134	F	F	F	VF	VF
TJ60-6502	F	F	F	F	F
TJ60-6503	M	F	F	F	F
TJ60-6504	M	M	M	M	F
TJ60-6506	M	M	M	M	M
TJ60-6508	C	C	M	M	M
TJ60-8001	VF	VF	VF	VF	VF
TJ60-8002	F	F	F	F	F
TJ60-8003	F	F	F	F	F
TJ60-8004	M	M	F	F	F
TJ60-8005	M	M	M	F	F
TJ60-8006	M	M	M	M	M
TJ60-8008	C	M	M	M	M
TJ60-8010	C	C	C	M	M
TJ60-11002	F	VF	VF	VF	VF
TJ60-11003	F	F	F	F	F
TJ60-11004	F	F	F	F	F
TJ60-11005	M	M	F	F	F
TJ60-11006	M	M	M	F	F
TJ60-11008	M	M	M	M	M
TJ60-11010	M	M	M	M	M

**DG TeeJet® (DG E)**

	bar				
	2	2.5	3	3.5	4
DG95015E	M	M	F	F	F
DG9502E	M	M	M	M	M
DG9503E	C	M	M	M	M
DG9504E	C	C	M	M	M
DG9505E	C	C	C	M	M

**DG TeeJet® (DG)**

	bar				
	2	2.5	3	3.5	4
DG80015	M	M	M	M	F
DG8002	C	M	M	M	M
DG8003	C	M	M	M	M
DG8004	C	C	M	M	M
DG8005	C	C	C	M	M
DG110015	M	F	F	F	F
DG11002	M	M	M	M	M
DG11003	C	M	M	M	M
DG11004	C	C	M	M	M
DG11005	C	C	C	M	M

# Drift Causes and Control



Figure 1. This is not what crop protection should look like!

When applying crop protection chemicals, spray drift is a term used for those droplets containing the active ingredients that are not deposited on the target area. The droplets most prone to spray drift are usually small in size, less than 200 µm micron in diameter and easily moved off the target area by wind or other climatic conditions. Drift can cause crop protection chemicals to be deposited in undesirable areas with serious consequences, such as:

- Damage to sensitive adjoining crops.
- Surface water contamination.
- Health risks for animals and people.
- Possible contamination to the target area and adjacent areas or possible over-application within the target area.

## Causes of Spray Drift

A number of variables contribute to spray drift; these are predominantly due to the spray equipment system and meteorological factors.

### ■ Droplet Size

Within the spray equipment system, drop size is the most influential factor related to drift.

When a liquid solution is sprayed under pressure it is atomized into droplets of varying sizes: **The smaller the nozzle size and the greater the spray pressure, the smaller the droplets and therefore the greater the proportion of driftable droplets.**

### ■ Spray Height

As the distance between the nozzle and the target area increases, the greater impact wind velocity can have on drift. The influence of wind can increase the proportion of smaller drops being carried off target and considered drift.

**Do not spray at greater heights than those recommended by the spray tip manufacturer, while taking care not to spray below the minimum recommended heights. (Optimum spray height 75 cm for 80° spray tips, 50 cm for 110° spray tips.)**

### ■ Operating Speed

Increased operating speeds can cause the spray to be diverted back into upward wind currents and vortices behind the sprayer, which traps small droplets and can contribute to drift.

**Apply crop protection chemicals according to good, professional practices at maximum operating speeds of 6 to 8 km/h (with air induction type nozzles—up to 10 km/h). As wind velocities increase, reduce operating speed.\***

\* Liquid fertilizer applications using the TeeJet® tips with very coarse droplets can be performed at higher operating speeds.

### ■ Wind Velocity

Among the meteorological factors affecting drift, wind velocity has the greatest impact. Increased wind speeds cause increased spray drift. It is common knowledge that in most parts of the world the wind velocity is variable throughout the day (see Figure 2). Therefore, it is important for spraying to take place during the relatively calm hours of the day. The early morning and early evening are usually the most calm. **Refer to chemical label for velocity recommendations.** When spraying with traditional techniques the following rules-of-thumb apply:

In low wind velocity situations, spraying can be performed at recommended nozzle pressures.

As wind velocities increase up to 3 m/s, spray pressure should be reduced and nozzle size increased to obtain larger droplets that are less prone to drift. Wind measurements should be taken throughout the spraying operation with a wind meter or anemometer. As the risk of spray drift increases, selecting designed to more coarse droplets that are less prone to drift is extremely important. Some such TeeJet nozzles that fit into this category are: DG TeeJet®, Turbo TeeJet®, AI TeeJet®, Turbo TeeJet® Induction, and AIXR TeeJet®.

When wind velocities exceed 5 m/s (11 MPH), spraying operation should not be performed.

### ■ Air Temperature and Humidity

In ambient temperatures over 25°C/77°F with low relative humidity, small droplets are especially prone to drift due to the effects of evaporation.

**High temperature during the spraying application may necessitate system changes, such as nozzles that produce a coarser droplet or suspending spraying.**

### ■ Crop Protection Chemicals and Carrier Volumes

Before applying crop protection chemicals, the applicator should read and follow all instructions provided by the manufacturer. Since extremely low carrier volume usually necessitates the use of small nozzle sizes, the drift potential is increased. As high a carrier volume as practical is recommended.

## Application Regulations for Spray Drift Control

In several European countries, regulatory authorities have issued application regulations in the use of crop protection chemicals to protect the environment. In order to protect the surface waters and the field buffer areas (examples are: hedges and grassy areas of a certain width) distance requirements must be kept because of spray drift. Inside the European Union (EU) there is a directive for the harmonization of crop protection chemicals in regard to environmental protection. In this respect the procedures that have been implemented in Germany, England and the Netherlands will be established in other EU countries in the coming years.

To reach the objectives for environmental protection, spray drift reducing measures have been integrated as a central instrument in the practice of risk evaluation. For example, buffer zones may be reduced in width if certain spraying techniques or equipment are used that have been approved and certified by certain regulatory agencies. Many of the TeeJet nozzles designed for reducing spray drift have been approved and certified in several EU countries. The certification of those registrars fits into a drift reduction category, such as 90%, 75%, or 50% (90/75/50) control of drift (see page 186). This rating is related to the comparison of the BCPC reference nozzle capacity of 03 at 3 bar.

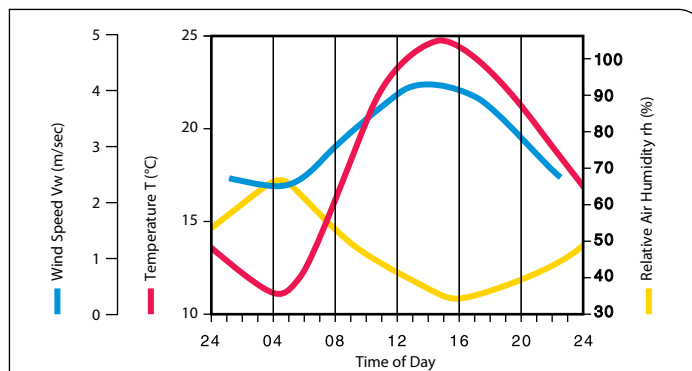

Figure 2. Development of wind velocity, air temperature and relative air humidity (example). From: Malberg

## Nozzles for Spray Drift Control

Drift potential can be minimized even when it is necessary to use small nozzle capacities by selecting nozzle types that produce larger Volume Median Diameter (VMD) droplets and a lower percentage of small droplets. Figure 4 is an example showing VMD's produced by nozzles of identical flow rates (size 11003) which produce coarser droplets than an XR TeeJet and then larger droplets in sequence; TT/TTJ60, AIXR, AI and TTI. TTI nozzles produce the coarsest droplet size spectrum of this group. When operating at a pressure of 3 bar (50 PSI) and 7 km/h (5 MPH) ground speed, the application rate is 200 l/ha (20 MPH). At the same time, the observation is that the VMD increases significantly from the XR to the TTI. This shows that it is possible to cover the entire droplet size spectrum from very fine to extremely coarse droplets by using different types of nozzles. While susceptibility to drift decreases when droplets become larger, the number of droplets available may lead to less uniform coverage. To compensate for this drawback and for the chemical to be effective, it is necessary to apply the optimum pressure range specified for a particular type of nozzle. If applicators comply with the parameters set by the manufacturers, they will always cover 10–15% of the target surface on average, which is not least attributed to the fact that less drift translates into more effective

coverage. Figure 4 shows the VMD curves by nozzle type indicating the optimum pressure ranges for the individual nozzles which should be selected with respect to both effective drift control and effect of the chemical. When the focus is on drift control, TT, TTJ60 and AIXR are operated at pressures of less than 2 bar (29.5 PSI). Yet, where maximum effect is critical, the nozzles are operated at pressures between 2 bar (29.5 PSI) and 3.5 bar (52 PSI) or even higher in specific conditions. These pressure ranges do not apply to AI and TTI, which operate at less than 3 bar (43.5 PSI) when drift control is critical and always at 4 bar (58 PSI) and 7 bar (101.5 PSI) and even 8 bar (116 PSI) when the emphasis is on chemical affect. Therefore, for applicators to select the correct nozzle size it is necessary to consider the spray pressure at which a chemical is most effective. With this, they simply have to reduce pressure and ground speed to comply with statutory buffer strip requirements. It is down to the conditions prevailing at the individual farm (location of the field, number of water bodies, type of chemical applied, etc.) whether they should choose a TeeJet nozzle that reduces drift by 50%, 75% or 90%. On principle, applicators should use 75% or 90% drift control nozzles (extremely coarse droplets) only when spraying near field boundaries and 50% or less TeeJet nozzles in all other areas of the field.

While the classic XR TeeJet orifice provides two functions; metering the volume flow rate and distributing and creating the droplets, all other nozzle types discussed above use a pre-orifice for metering while distribution and droplet creation takes place at the exit orifice (Fig. 3). Both functions and devices relate to each other with respect to geometry and spacing and interact with respect to the droplet size produced. The TT, TTJ60 and TTI nozzles force the liquid to

change direction after it has passed the pre-orifice, forcing it into a horizontal chamber and to change direction again into the nearby vertical passage in the orifice itself (global patent). The AI, AIXR and TTI air induction nozzles operate on the Venturi principle, where the pre-orifice generates a higher-velocity stream, aspirating air through the side holes. This specific air / liquid mix creates more coarse droplets that are filled with air, depending on the chemical used.

## Summary

Successful drift management centers on sound knowledge about drift contributing factors and the use of drift control, TeeJet nozzles. To strike a sound balance between successful chemical application and environmental protection, applicators should use approved broadcast TeeJet nozzles that are classified as drift control and operate these within the pressure ranges that ensure chemical effectiveness; i.e. set nozzles to 50% drift control or less. The following list shows all the relevant factors that need to be considered, optimized or applied to achieve effective drift control:

- Low-Drift TeeJet nozzles
- Spraying pressure and droplet size
- Application rate and nozzle size
- Spraying height
- Forward speed
- Wind velocity
- Ambient temperature and relative humidity
- Buffer strips (or apply options that allow reducing the width of buffer strips)
- Compliance with manufacturer instructions

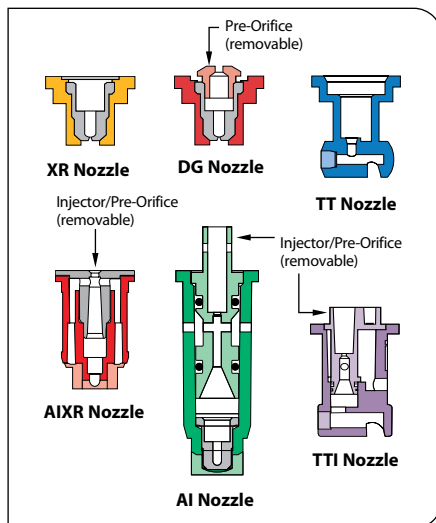

Figure 3: XR, DG, TT, AIXR, AI and TTI nozzles (sectional drawings).

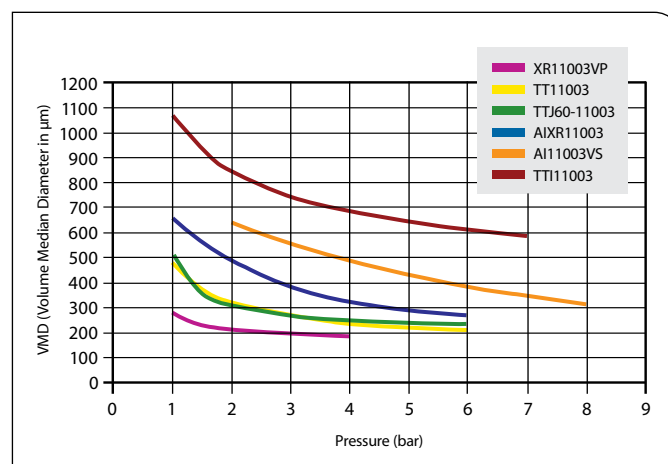

Figure 4. Volumetric droplet diameters of XR, TT, TTJ60, AIXR, AI and TTI nozzles relative to pressure

Measurement conditions:

- Continuous Oxford Laser measurement across the full width of the flat spray
- 50 cm space (in nozzle axis)
- Water temperature 21 °C

# Assessment of Nozzle Drift Control in Europe

Several European countries now consider it important to assess nozzles for spray drift control as this enables general cooperation between agriculture, nature conservation and environmental protection. Although spray pattern distribution testing has been carried out for several decades (see page 180), preliminary assessment criteria for drift control during chemical applications were first defined in the 1980's and 1990's. A minimum value was determined for the small droplet ratio ( $D_{v0.1}$ ) of nozzles. The development of the XR TeeJet® nozzles, together with the first generation of drift control nozzles (DG TeeJet®), achieved significant advances in crop protection technology. However, these proved insufficient as environmental regulations on chemical application became more and more restrictive. Stricter requirements for buffer strips to protect surface water and sensitive areas around fields in particular have led to the development of a program that assesses nozzle drift control as well as to innovative nozzles producing larger droplet sizes. While nozzle development is described on pages 184 and 185, priority here is given to describing drift control evaluation programs.

## Drift control assessment systems in Europe

Countries such as the UK, the Netherlands and Germany do not use standardized systems for measuring reduction in drift. However, one aspect shared by all systems is they all use a reference system based on the 03 nozzle specified in the BCPC droplet size classification scheme at 43,5 PSI (3 bar) pressure and at a spray height of 19.7" (50 cm) above the target surface. Drift from this nozzle is defined as 100%. The drift control levels from other nozzle types at the same pressure are compared with this reference nozzle. For example, a nozzle categorized as 50% produces at least 50% less drift than the reference nozzle. The countries mentioned above have compiled corresponding percentage drift control categories, which vary from one another in some areas and are valid only at a national level.

While in Germany drift control categories of 50% / 75% / 90% / 99% apply, they are categorized as 50% / 75% / 90% / 95% in the Netherlands and as 25% / 50% / 75% in the UK. Furthermore, the same nozzle type and size operated at the same pressure may be categorized as 50% in country A and 75% in country B. This is due to different methods of measurement and calculation. The future may lead to international standardization emerging over the next few years as a result of approaching EU harmonization. At present, TeeJet Technologies is obliged to test new developments and have them assessed in each of these countries to verify the effectiveness of the technical advances so farmers can use our products without fearing conflict with the government.

## The system in Germany

In Germany, the Federal Biological Research Center for Agriculture and Forestry (BBA), is responsible for testing nozzles for agricultural use. Drift measurements are taken in the field under the most standardized conditions possible for temperature, wind direction, wind velocity and forward speed. This method is mandatory for testing air-assisted sprayers and their affect on nozzles used on permanent crops such as orchards and vineyards. Thanks to field measurements recorded over many years and their high correlation with temperature-controlled wind tunnel measurements, drift measurements on agricultural nozzles can now also be conducted at the BBA wind tunnel in absolutely standardized conditions. In all cases, tracer methods are used to quantify droplets of a high detection limit on artificial collectors and feed the data into a „DIX model“ (drift potential index). This gives DIX values expressed as categories in the percentage drift reduction classes.

## The system in the UK

The UK currently uses only one assessment system for agricultural nozzles. The Pesticide Safety Directorate (PSD) evaluates data recorded in the wind tunnel, but in contrast to the BBA, it records the droplets landed on horizontal collectors. The climatic conditions are standardized as well. The test nozzle is compared with the BCPC reference nozzle and awarded a corresponding star rating where one

star equates to drift levels up to 75%, two stars up to 50% and three stars up to 25% of those of the reference system.

## The system in the Netherlands

Although the Dutch have used an assessment system for agricultural nozzles for several years (Lozingenbesluit Open Teelten Veehouderij/ Water Pollution Act, Sustainable Crop Protection), they are about to introduce a system for nozzles used in orchard spraying. Agrotechnology & Food Innovations B.V. (WageningenUR) is in charge of the measurements. A Phase Doppler Particle Analyzer (PDPA laser) is used to investigate the droplets and droplet speed from a nozzle offering the following characteristics:  $D_{v0.1}$ , VMD,  $D_{v0.9}$  and volume fraction <100µm. The data collected is then fed into the IDEFICS model. The calculation also factors in a reference crop and stage, a buffer strip in the field, forward speed and defined weather conditions to arrive at a percentage nozzle classification for the particular spray pressure under examination. Approval bodies such as CTB (75% / 90% / 95%) and RIZA (50%) publish the classifications.

## Benefits and options for users

The use of drift control nozzles brings significant benefits to users in the countries listed, as well as others around the world. Depending on the location of the fields relative to environmentally sensitive areas such as surface water and field boundaries, applicators can reduce the width of buffer strips, as stipulated by the relevant restrictions in association with the approval of the chemical (e.g. 20 meter no-spray buffer strips). Consequently, it is possible to apply chemicals subject to restrictions in field margins near surface water etc., provided that the user complies with the national application regulations. If the directions of use for a particular product require a 75% reduction of drift, allowing for carrier volume and travel speed, it will be necessary to use a nozzle with a 75% drift control classification and operate it at the spray pressure specified. As a general rule, forward speed can be optimized so that the same nozzle can be used near the field boundaries as well as within the middle of the applied field area. With this, the carrier volume remains constant in different situations. Since it is possible to define minimum buffer strip widths for all applications at a national level as well, these must always be considered on a case by case basis.

In general, for successful crop protection, it is necessary to select nozzles of a high percentage classification (75% or higher) only in those situations where statutory buffer strip requirements apply. Otherwise, we suggest using nozzles at a spray pressure achieving a 50% drift control or using non-classified nozzles.

For further information about the low-drift categories of TeeJet nozzles, contact your TeeJet representative or go to [www.teejet.com](http://www.teejet.com).



# Plumbing Diagrams

The following diagrams have been developed to serve as a guideline for plumbing agricultural sprayers. Similar manual valves may be substituted for electric valves. However, the sequence in which these valves occur should remain the same. Note that one of the most common causes of premature valve failure is improper installation.

## Positive Displacement Pump

Piston, roller and diaphragm pumps are all types of positive displacement pumps. This means that pump output is proportional to speed and virtually independent of pressure. A key component in a positive displacement system is the pressure relief valve. Proper placement and sizing of the pressure relief valve is essential for safe and accurate operation of a positive displacement pump.

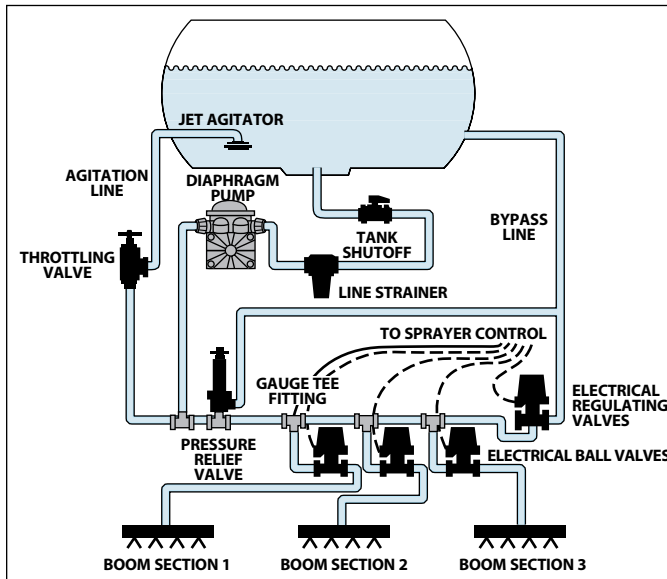

**Two-Way Plumbing Diagram (Positive Displacement)**

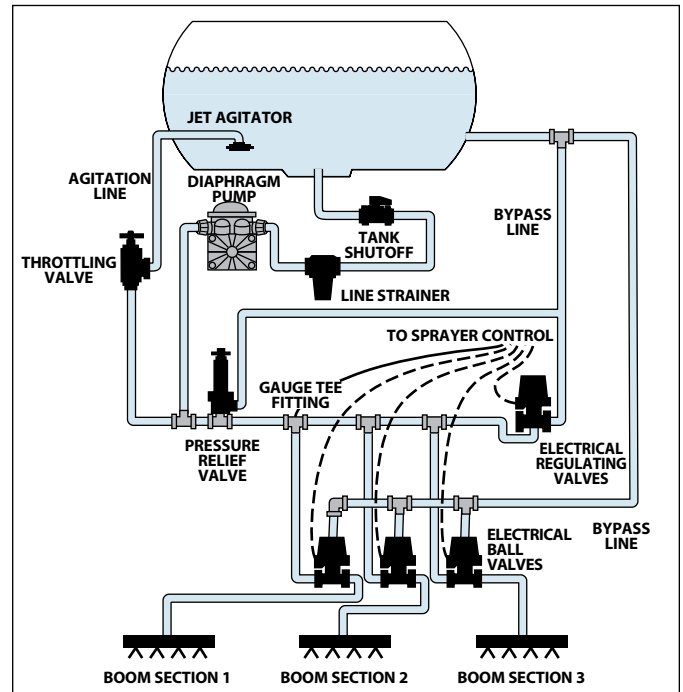

**Three-Way Plumbing Diagram (Positive Displacement)**

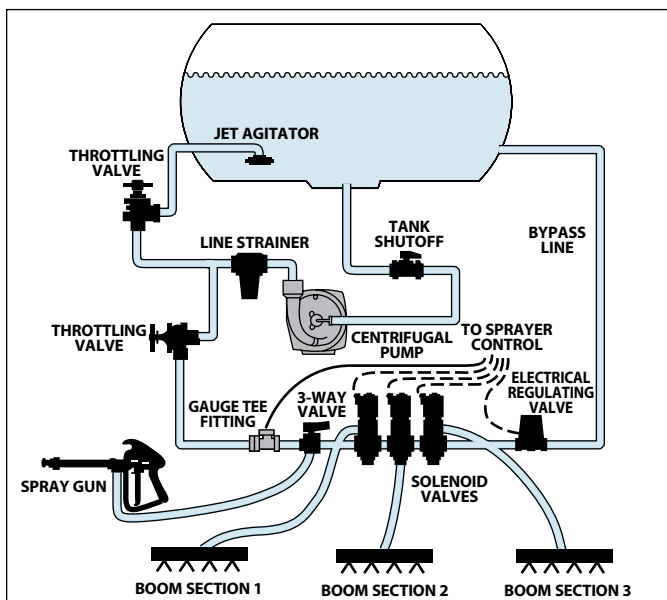

**Two-Way Plumbing Diagram (Non-Positive Displacement)**

## Non-Positive Displacement Pump

The centrifugal pump is the most common non-positive displacement pump. The output from this type of pump is influenced by pressure. This pump is ideal for delivering large volumes of liquid at low pressures. A key component of the centrifugal pump is the throttling valve. A manual throttling valve on the main output line is essential for the accurate operation of the centrifugal pump.

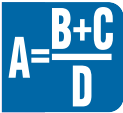

## UNITED STATES

**COLORADO, MINNESOTA, NEW MEXICO,  
NORTH DAKOTA, OKLAHOMA, SOUTH  
DAKOTA, TEXAS, WISCONSIN, WYOMING**

### TeeJet Sioux Falls

P.O. Box 1145  
Sioux Falls, SD 57101-1145  
Sales Related Inquiries: (605) 338-5633  
Electronics and Guidance Technical Support:  
(217) 747-0235  
Nozzles and Accessories Technical Support:  
(630) 665-5983  
Email: info.siouxfalls@teejet.com

**ARIZONA, CALIFORNIA, HAWAII, IDAHO,  
NEVADA, OREGON, UTAH, WASHINGTON**

### TeeJet West

1801 Business Park Drive  
Springfield, IL 62703  
Sales Related Inquiries: (217) 241-1718  
Electronics and Guidance Technical Support:  
(217) 747-0235  
Nozzles and Accessories Technical Support:  
(630) 665-5983  
Email: info.west@teejet.com

**ALABAMA, ARKANSAS, FLORIDA,  
GEORGIA, LOUISIANA, MISSISSIPPI,  
SOUTH CAROLINA, TENNESSEE**

### TeeJet Memphis

P.O. Box 997  
Collierville, TN 38027  
Sales Related Inquiries: (901) 850-7639  
Electronics and Guidance Technical Support:  
(217) 747-0235  
Nozzles and Accessories Technical Support:  
(630) 665-5983  
Email: info.memphis@teejet.com

**ALASKA, MONTANA**

### TeeJet Saskatoon

P.O. Box 698  
Langham, Saskatchewan  
Canada S0K 2L0  
Sales Related Inquiries: (306) 283-9277  
Electronics and Guidance Technical Support:  
(217) 747-0235  
Nozzles and Accessories Technical Support:  
(630) 665-5983  
Email: info.saskatoon@teejet.com

**CONNECTICUT, DELAWARE, DISTRICT OF  
COLUMBIA, INDIANA, KENTUCKY, MAINE,  
MARYLAND, MASSACHUSETTS, MICHIGAN,  
NEW HAMPSHIRE, NEW JERSEY, NEW  
YORK, NORTH CAROLINA, OHIO,  
PENNSYLVANIA, RHODE ISLAND,  
VERMONT, VIRGINIA, WEST VIRGINIA**

### TeeJet Harrisburg

124A West Harrisburg Street  
Dillsburg, PA 17019  
Sales and Technical Support: (717) 432-7222  
Email: info.harrisburg@teejet.com

**ILLINOIS, IOWA, KANSAS,  
MISSOURI, NEBRASKA**

### TeeJet Des Moines

3062 104th Street  
Urbandale, IA 50322  
Sales and Technical Support: (515) 270-8415  
Email: info.desmoines@teejet.com

## CANADA

**ALBERTA, BRITISH COLUMBIA, MANITOBA,  
SASKATCHEWAN**

### TeeJet Saskatoon

P.O. Box 698  
Langham, Saskatchewan  
Canada S0K 2L0  
Sales Related Inquiries: (306) 283-9277  
Electronics and Guidance Technical Support:  
(217) 747-0235  
Nozzles and Accessories Technical Support:  
(630) 665-5983  
Email: info.saskatoon@teejet.com

**NEW BRUNSWICK, NEWFOUNDLAND,  
NOVA SCOTIA, ONTARIO, PRINCE  
EDWARD ISLAND, QUÉBEC**

### TeeJet Harrisburg

124A West Harrisburg Street  
Dillsburg, PA 17019  
Sales and Technical Support: (717) 432-7222  
Email: info.harrisburg@teejet.com



## MEXICO, CENTRAL AMERICA & THE CARIBBEAN

BELIZE, COSTA RICA, DOMINICAN REPUBLIC, EL SALVADOR, GUATEMALA, HAITI, HONDURAS, JAMAICA, MEXICO, NICARAGUA, PANAMA, PUERTO RICO, THE VIRGIN ISLANDS

### TeeJet Mexico, Central America, The Caribbean

Acceso B No. 102  
Parque Industrial Jurica  
76120 Queretaro, Qro.  
México

Sales and Technical Support:  
(52) 442-218-4571

Fax: (52) 442-218-2480

Email: [info.mexico@teejet.com](mailto:info.mexico@teejet.com)



## SOUTH AMERICA

ARGENTINA, BOLIVIA, BRAZIL, CHILE, COLOMBIA, ECUADOR, FRENCH GUYANA, GUYANA, PARAGUAY, PERU, SURINAME, URUGUAY, VENEZUELA

### TeeJet South America

Avenida João Paulo Ablas, nº 287  
CEP: 06711-250  
Cotia - São Paulo - Brazil

Sales and Technical Support:  
55-11-4612-0049

Fax: 55-11-4612-9372

Email: [info.southamerica@teejet.com](mailto:info.southamerica@teejet.com)

## EUROPE

**ALBANIA, BOSNIA & HERZEGOVINA, BULGARIA, CROATIA, GREENLAND, ICELAND, IRELAND, MACEDONIA, THE NETHERLANDS, SERBIA, MONTENEGRO, SLOVENIA, UNITED KINGDOM**

### TeeJet London

Headley House, Headley Road  
Grayshott, Hindhead  
Surrey GU26 6UH  
United Kingdom

Sales and Technical Support:  
+44 (0) 1428 608888

Fax: +44 (0) 1428 608488

Email: info.london@teejet.com

**DENMARK, ESTONIA, FINLAND, LATVIA, LITHUANIA, NORWAY, SWEDEN**

### TeeJet Aabybro

Mølhavevej 2  
DK 9440 Aabybro  
Denmark

Sales and Technical Support:  
+45 96 96 25 00

Fax: +45 96 96 25 01

Email: info.aabybro@teejet.com

**ANDORRA, BELGIUM, FRANCE, GREECE, ITALY, LICHTENSTEIN, LUXEMBOURG, MONACO, PORTUGAL, SWITZERLAND, SPAIN**

### TeeJet Orleans

431 Rue de la Bergeresse  
45160 Olivet (Orleans)  
France

Sales and Technical Support:  
+33 (0) 238 697070

Fax.: +33 (0) 238 697071

Email: info.orleans@teejet.com

**AUSTRIA, GERMANY**

### TeeJet Bomlitz

August-Wolff-Strasse 16  
D-29699 Bomlitz  
Germany

Sales and Technical Support:  
+49 (0) 5161 4816-0

Fax: +49 (0) 5161 4816-16

Email: info.bomlitz@teejet.com

**ARMENIA, AZERBAIJAN, BELARUS, CZECH REPUBLIC, GEORGIA, HUNGARY, KAZAKHSTAN, KYRGYZSTAN, MOLDOVA, POLAND, RUSSIA, ROMANIA, SLOVAKIA, TAJIKISTAN, TURKMENISTAN, UZBEKISTAN, UKRAINE**

### TeeJet Poland

Ul. Mickiewicza 35  
60-837 Poznań  
Poland

Sales and Technical Support:  
+48 (0) 61 8430280, 61 8430281

Fax: +48 (0) 61 8434041

Email: info.poland@teejet.com

## MIDDLE EAST

**ISRAEL, JORDAN, LEBANON, SAUDI ARABIA, SYRIA, TURKEY**

### TeeJet Orleans

431 Rue de la Bergeresse  
45160 Olivet (Orleans)  
France

Sales and Technical Support:  
+33 (0) 238 697070

Fax.: +33 (0) 238 69 70 71

Email: info.orleans@teejet.com

## AFRICA

**ALGERIA, EGYPT, LIBYA, MOROCCO, TUNISIA**

### TeeJet Orleans

431 Rue de la Bergeresse  
45160 Olivet (Orleans)  
France

Sales and Technical Support:  
+33 (0) 238 697070

Fax.: +33 (0) 238 69 70 71

Email: info.orleans@teejet.com

**SOUTH AFRICA**

### Monitor Engineering Co. Pty. Ltd.

132 Main Reef Road, Benrose  
Johannesburg, 2094 South Africa

Sales and Technical Support: 27 11 618 3860

Fax: 27 11 614 0021

Email: info.teejet@icon.co.za

## ASIA-PACIFIC

### CHINA

#### Spraying Systems (Shanghai) Co., Ltd.

21# Shulin Road  
(Songjiang Industry Zone New East Part)  
Songjiang District, 201611 Shanghai, China  
Sales and Technical Support:  
86 139 4567 1289  
Fax: 86 21 5046 1043  
Email: info.shanghai@teejet.com

### HONG KONG

#### Spraying Systems Co. Ltd.

Flat B3, 3/Floor, Tai Cheung Factory Building  
3 Wing Ming Street, Cheung Sha Wan  
Kowloon, Hong Kong  
Sales and Technical Support: (852) 2305-2818  
Fax: 85 22 7547786  
Email: info.TeeJet@spray.com.hk

### JAPAN

#### Spraying Systems Japan Co. (Head Office)

TK Gotanda Building 8F  
10-18, Higashi-Gotanda 5-Chome  
Shinagawa-ku Tokyo, Japan 141-0022  
Sales and Technical Support: 81 3 34456031  
Fax: 81 3 34427494  
Email: info.teejet@spray.co.jp

#### Spraying Systems Japan Co. (Osaka Office)

3-8 1-Chome, Nagatanaka  
Higashi-Osaka City Osaka, Japan 577-0013  
Sales and Technical Support: 81 6 784 2700  
Fax: 81 6 784 8866  
Email: info.teejet@spray.co.jp

#### Spraying Systems Far East Co.

2-4 Midoridaira  
Sosa-City Chiba Prefecture, Japan 289-2131  
Sales and Technical Support: 81 479 73 3157  
Fax: 81 479 73 6671  
Email: info.teejet@spray.co.jp

### KOREA

#### Spraying Systems Co. Korea

Room No. 112, Namdong Apartment Factory  
151BL-6L, 722, Kojan-Dong, Namdong-Gu  
Incheon City, Korea  
Sales and Technical Support:  
82-32-821-5633,9  
Fax: 82-32-811-6629  
Email: info.teejet@spray.co.kr

### SINGAPORE

#### Spraying Systems Co. (Singapore) Pte Ltd

55 Toh Guan Road East  
#06-02 Uni-Tech Centre  
Singapore 608601  
Sales and Technical Support: 65 – 67786911  
Fax: 656 778 2935  
Email: info.teejet@spraying.com.sg

### TAIWAN

#### Spraying Systems (Taiwan) Ltd.

P.O. Box 46-55  
11th Floor, Fortune Building  
52, Sec. 2, Chang An East Road  
Taipei 104, Taiwan  
Sales and Technical Support: 886 2 521 0012  
Fax: 886 2 5215295  
Email: info.teejet@spraytwn.com.tw

## AUSTRALIA & OCEANIA

### AUSTRALIA, PAPUA NEW GUINEA, NEW ZEALAND

#### TeeJet Australasia Pty. Ltd.

P.O. Box 8128  
65 West Fyans St  
Newtown, Victoria 3220  
Australia  
Sales and Technical Support: 61 35 223 3020  
Fax: (61) 3 5223 3015  
Email: info.australia@teejet.com